

622/632

622/623-Series

SMALL-SIZED ROCKER SWITCHES

A high powered offering packed into a small-sized envelope, the 622/632-Series is a staple of numerous markets. With its silver-alloy butt contacts, the 622/632 will handle inrush spikes up to 100 amps and steady state current to 12A 125VAC. The lighted 632-Series features a multitude of illumination circuit options available with LED, incandescent and neon style lamps.



Product Highlights:

- ♦ Illuminated or Non-Illuminated
- ♦ Silver Plated Butt contacts that handle high Inrush spikes
- ♦ Independent or Dependent lamp circuitry
- ♦ Industry standard size mounting hole

Typical Applications:

- ♦ Appliance
- ♦ Food Service
- ♦ Transportation
- ♦ General Purpose



Dielectric Strength

UL/CSA:
1000V-live to dead metal parts
& opposite polarity

Electrical Life

50,000 cycles

Mechanical Life

100,000 cycles

Operating Temperature

32°F to 185°F (0°C to 85°C)

632121 - 1 B - K N

1 Base Part Number

2 Actuator Color

3 Base Color

4 Lamp

5 Legend

BASE PART NUMBER: SERIES / CIRCUITRY / RATING / TERMINATION

8A 250VAC; 12A 125VAC; 1/2 HP 125-250VAC
622-SERIES NON-ILLUMINATED ROCKER

ON-none-OFF (Single Pole)
ON-none-OFF (Double Pole)

632-SERIES ILLUMINATED ROCKER

ON-none-OFF (Single Pole, dependent lamp) schematic 1
ON-none-OFF (Single Pole, independent lamp) schematic 3
ON-none-OFF (Single Pole, independent lamp unballasted) schematic 5
ON-none-OFF (Double Pole, dependent lamp with 5 terms.) schematic 2
ON-none-OFF (Double Pole, dependent lamp with 4 terms.) schematic 4

Solder Lugs .187 Tabs

622121 622122
622221 622222

632121 632122
632321 632322
632521 632522
632221 632222
632421 632422

3 ACTUATOR COLOR³

622 (non illuminated)

B Black
W White

632 (illuminated)

1 Clear Amber
2 Clear Red
3 Clear Blue²
4 Clear Green
5 Clear

4 LAMP VOLTAGE / STYLE¹

N 622 (non illuminated)
1 unballasted LED
2 6V LED
3 12V LED
4 24V LED

A 6V incandescent
C 12V incandescent
E 18V incandescent
H 24V incandescent
J 125V neon
K 250V neon

3 BASE COLOR³

B Black

W White

5 ROCKER LEGEND

N NO Legend
A OFF-ON vertical
B OFF-ON horizontal
D I-O horizontal
E I-O vertical
F O on rocker radius

Notes:

- For all incandescent or LED lamps specify 5 in 5th digit of part number. Example 632151-1B-CN
- Available with incandescent lamps only.
- Additional colors available. Consult factory for details.

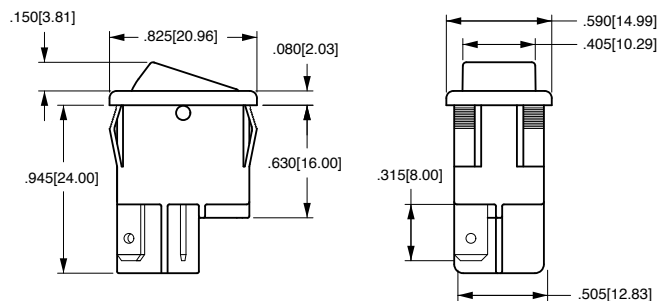

632 SCHEMATIC

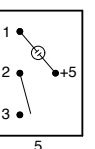
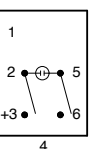
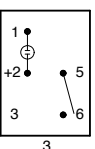
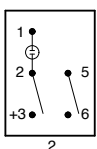
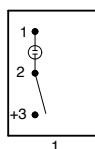

UNBALLASTED

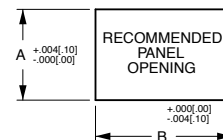
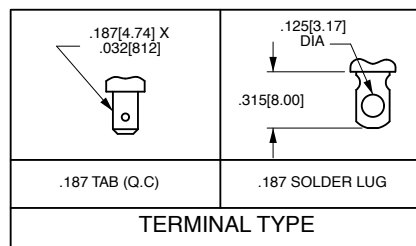

| PANEL THICKNESS | A | B |
|-----------------------|-------------|-------------|
| .030[.76]-.050[1.27] | .508[12.90] | .756[19.20] |
| .050[1.27]-.078[1.98] | .508[12.90] | .764[19.40] |
| .078[1.98]-.125[3.17] | .508[12.90] | .780[19.81] |

*Manufacturer reserves the right to change product specification without prior notice.

Authorized Sales Representatives and Distributors

Click on a region of the map below to find your local representatives and distributors or visit www.carlingtech.com/findarep.



About Carling

Founded in 1920, Carling Technologies is a leading manufacturer of electrical and electronic switches and assemblies, circuit breakers, electronic controls, power distribution units, and multiplexed power distribution systems. With four ISO registered manufacturing facilities and technical sales offices worldwide, Carling Technologies Sales, Service and Engineering teams do much more than manufacture electrical components, they engineer powerful solutions! To learn more about Carling please visit www.carlingtech.com/company-profile.

To view all of Carling's environmental, quality, health & safety certifications please visit www.carlingtech.com/environmental-certifications

Worldwide Headquarters

Carling Technologies, Inc.
60 Johnson Avenue, Plainville, CT 06062
Phone: 860.793.9281 **Fax:** 860.793.9231
Email: sales@carlingtech.com

Northern Region Sales Office: nrsm@carlingtech.com
Southeast Region Sales Office: sersm@carlingtech.com
Midwest Region Sales Office: mrrsm@carlingtech.com
West Region Sales Office: wrsm@carlingtech.com
Latin America Sales Office: larsm@carlingtech.com

Asia-Pacific Headquarters

Carling Technologies, Asia-Pacific Ltd.,
Suite 1607, 16/F Tower 2, The Gateway,
Harbour City, 25 Canton Road,
Tsimshatsui, Kowloon, Hong Kong
Phone: Int + 852-2737-2277 **Fax:** Int + 852-2736-9332
Email: sales@carlingtech.com.hk

Shenzhen, China: shenzhen@carlingtech.com
Shanghai, China: shanghai@carlingtech.com
Pune, India: india@carlingtech.com
Kaohsiung, Taiwan: taiwan@carlingtech.com
Yokohama, Japan: japan@carlingtech.com

Europe | Middle East | Africa Headquarters

Carling Technologies LTD
4 Airport Business Park, Exeter Airport,
Clyst Honiton, Exeter, Devon, EX5 2UL, UK
Phone: Int + 44 1392.364422 **Fax:** Int + 44 1392.364477
Email: ltd.sales@carlingtech.com

Germany: gmbh@carlingtech.com
France: sas@carlingtech.com



Carling Technologies®

Innovative Designs. Powerful Solutions.